



safety

FOR SAFE
WORKING LIVES

3

SYNTHETIC SLINGS



CATALOGUE **VOL1**





SYNTHETIC SLINGS

3



WE MANUFACTURE AND STOCK A DIVERSE RANGE OF FLAT, ROUND AND HEAVY LIFT TWIN-PATH SLINGS

with custom lengths available on request. Each sling is individually proof tested to Australian Standards and supplied with a Test Certificate. Capacities range from 0.5 tonne to 600 tonnes.

TYPES OF SLINGS	4-5
FLAT WEBBING SLINGS	6-9
ROUND SLINGS	10-14
TWIN-PATH® LIFTING SLINGS	15
TWIN-PATH® TECHNICAL SPECIFICATIONS	16-17
TWIN-PATH® ACCESSORIES	18
BOAT LIFTING SLINGS	19

TYPES OF SLINGS

SYNTHETIC SLINGS CAN BE USED FOR A VARIETY OF LIFTING AND TOWING APPLICATIONS AND HAVE MANY ADVANTAGES OVER LIFTING CHAIN, INCLUDING LOW WEIGHT, EASE OF HANDLING AND PROVIDING A NON DAMAGING LIFT TO MATERIAL.



TWIN-PATH® SLINGS

Our unique 'Twin-Path'™ licensed and patented sling range is made to order and used for heavy lifts up to 600 tonnes. The Twin-Path® range offers the ultimate in abrasion resistance and contains a check fast tag and external warning indicator for a pass/fail inspection of the internal load bearing core yarn.

The Twin-Path® is renowned as the market leader in ergonomic design and can be repaired in most instances.

WEBBING SLINGS

Synthetic webbing slings are high strength, low weight and easy to handle. In lifting applications they stretch less than rope slings but still absorb shock load extremely well.

The two most commonly used synthetic webbing slings used for lifting in Australia are 'Flat' and 'Round' Slings. Both types combine dimensional stability with great flexibility and shape instantly to the load cradling it with balance and security. They are very suitable for handling highly polished surfaces without damage, and are colour coded to conform to Australian Standards AS4497 and AS1353.

ENDLESS SLINGS

Endless Slings are made in both flat and round configurations and comply with the relevant Australian Standards.

Round Slings are manufactured from a hank of polyester yarn of one or more strands wound together continuously to form an endless sling. The sling is protected by an outer sleeve which is non-load bearing.

Endless Flat Slings are manufactured from woven synthetic-fibre webbing and sewn together to form an endless sling. The Endless Flat Slings come in both single and double ply configurations.

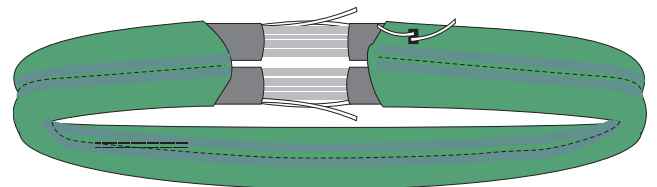

Twin-Path® Sling

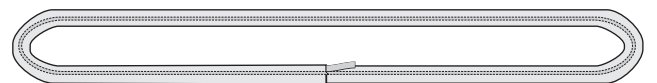

Mega Round Sling

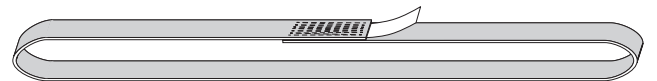

Single Ply Endless Flat Sling

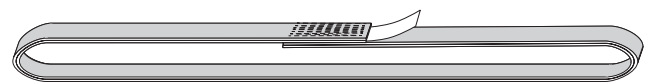





Double Ply Endless Flat Sling



Single Ply Flat Sling with Formed Eye

POLYESTER ROUND SLINGS & FLAT WEBBING SLINGS

WORKING LOAD LIMITS (WLL) CHART

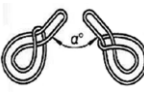
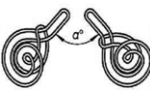
WORKING LOAD LIMITS UNDER GENERAL CONDITIONS OF USE - T									
COLOUR	MARKED WLL	STRAIGHT LIFT	CHOKED STRAIGHT LIFT	PARALLEL BASKET	BASKET HITCH OR 2, 3 AND 4 LEGS SLINGS			CHOKE HITCH OR 2, 3 AND 4 LEGS SLINGS	
					$\alpha = 60^\circ$	$\alpha = 90^\circ$	$\alpha = 120^\circ$	SINGLE WRAP $\alpha = \text{MAX } 45^\circ$	DOUBLE WRAP $\alpha = \text{MAX } 60^\circ$
									
	LOADING FACTORS	1	0.8	2	1.73	1.41	1	1.38	1.38
VIOLET	1	1	0.8	2	1.7	1.4	1		1.38
GREEN	2	2	1.6	4	3.4	2.8	2		2.76
YELLOW	3	3	2.4	6	5.1	4.2	3		4.14
GREY	4	4	3.2	8	6.9	5.6	4		5.52
RED	5	5	4	10	8.6	7	5		6.9
BROWN	6	6	4.8	12	10.3	8.4	6		8.28
BLUE	8	8	6.4	16	13.8	11.2	8		11.04
ORANGE	10	10	8	20	17.3	14.1	10		13.8
ORANGE	GREATER THAN 10	MARKED WLL X LF	MARKED WLL X LF	MARKED WLL X LF	MARKED WLL X LF	MARKED WLL X LF	MARKED WLL X LF		MARKED WLL X LF

Note: The WLL applicable to each configuration is the marked WLL multiplied by the loading factor, L.

CARE AND USE

Check Australian Standard AS4497 and AS1353 for use and inspection guidelines

Never overload the equipment

Do not use if ID tag is removed

Inspect sling for damage prior to use

Do not use sling if there is any sign of cut webbing, snagging, heat or chemical damage, excessive wear, damaged seams, any other defect or presence of grit, abrasive materials or other deleterious matter

Do not tie knots in sling webbing

Protect sling webbing from sharp edges of load. Use protective sleeves

Do not expose slings to temperatures above 90°C

Do not allow abrasive or other damaging grit to penetrate the fibres

Consult with manufacturer's recommendations before immersing a sling in a chemical solution

Keep away from strong alkalis and phenolic compounds.



FLAT WEBBING SLINGS



Flat Slings, commonly known as webbing slings, are an all-purpose lifting sling enabling a strong and non-damaging lift of a load. They are extremely light weight and flexible. The Beaver Flat Sling is made from polyester webbing sewn into a continuous length with an eye at each end. When used they cover a broad support area, which cushions the load against damage and reduces slipping. The low stretch characteristics of the polyester webbing also prevent 'load bounce' when lifting.

DOUBLE PLY FLAT SLINGS

FEATURES AND BENEFITS

- Made from 2 ply polyester webbing
- Light weight & flexible with sewn eyes each end
- Colour coded to International Lifting Standards

STANDARDS

Manufactured & certified to AS1353

CODE	WLL (KG)	LENGTH (M)	WIDTH (MM)	COLOUR	UOM	PACK QTY
FS-2-1000X1	1000	1	50	Violet	Each	40
FS-2-1000X1.5	1000	1.5	50	Violet	Each	30
FS-2-1000X2	1000	2	50	Violet	Each	30
FS-2-1000X2.5	1000	2.5	50	Violet	Each	25
FS-2-1000X3	1000	3	50	Violet	Each	20
FS-2-1000X3.5	1000	3.5	50	Violet	Each	20
FS-2-1000X4	1000	4	50	Violet	Each	20
FS-2-1000X4.5	1000	4.5	50	Violet	Each	15
FS-2-1000X5	1000	5	50	Violet	Each	15
FS-2-1000X6	1000	6	50	Violet	Each	15
FS-2-1000X8	1000	8	50	Violet	Each	10

Note: Other lengths and sizes available on request.



DOUBLE PLY FLAT SLINGS

FEATURES AND BENEFITS

- Made from 2 ply polyester webbing
- Light weight & flexible with sewn eyes each end
- Colour coded to International Lifting Standards

STANDARDS

Manufactured & certified to AS1353

CODE	WLL (KG)	LENGTH (M)	WIDTH (MM)	COLOUR	UOM	PACK QTY
FS-2-2000X1	2000	1	60	Green	Each	20
FS-2-2000X1.5	2000	1.5	60	Green	Each	20
FS-2-2000X2	2000	2	60	Green	Each	15
FS-2-2000X2.5	2000	2.5	60	Green	Each	12
FS-2-2000X3	2000	3	60	Green	Each	12
FS-2-2000X3.5	2000	3.5	60	Green	Each	10
FS-2-2000X4	2000	4	60	Green	Each	10
FS-2-2000X4.5	2000	4.5	60	Green	Each	8
FS-2-2000X5	2000	5	60	Green	Each	8
FS-2-2000X6	2000	6	60	Green	Each	8
FS-2-2000X8	2000	8	60	Green	Each	5

Note: Other lengths and sizes available on request.





DOUBLE PLY FLAT SLINGS

FEATURES AND BENEFITS

- Made from 2 ply polyester webbing
- Light weight & flexible with sewn eyes each end
- Colour coded to International Lifting Standards

STANDARDS

Manufactured & certified to AS1353

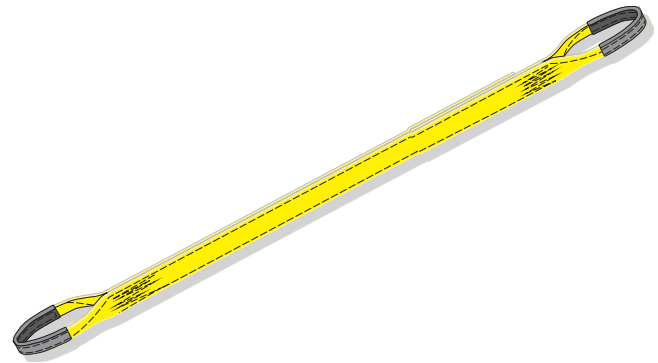

CODE	WLL (KG)	LENGTH (M)	WIDTH (MM)	COLOUR	UOM	PACK QTY
FS-2-3000X1	3000	1	90	Yellow	Each	15
FS-2-3000X1.5	3000	1.5	90	Yellow	Each	12
FS-2-3000X2	3000	2	90	Yellow	Each	12
FS-2-3000X2.5	3000	2.5	90	Yellow	Each	10
FS-2-3000X3	3000	3	90	Yellow	Each	9
FS-2-3000X3.5	3000	3.5	90	Yellow	Each	7
FS-2-3000X4	3000	4	90	Yellow	Each	6
FS-2-3000X4.5	3000	4.5	90	Yellow	Each	6
FS-2-3000X5	3000	5	90	Yellow	Each	5
FS-2-3000X6	3000	6	90	Yellow	Each	4
FS-2-3000X8	3000	8	90	Yellow	Each	3

Note: Other lengths and sizes available on request.



DOUBLE PLY FLAT SLINGS

FEATURES AND BENEFITS

- Made from 2 ply polyester webbing
- Light weight & flexible with sewn eyes each end
- Colour coded to International Lifting Standards

STANDARDS

Manufactured & certified to AS1353



CODE	WLL (KG)	LENGTH (M)	WIDTH (MM)	COLOUR	UOM	PACK QTY
FS-2-4000X2	4000	2	120	Grey	Each	8
FS-2-4000X2.5	4000	2.5	120	Grey	Each	7
FS-2-4000X3	4000	3	120	Grey	Each	6
FS-2-4000X4	4000	4	120	Grey	Each	4
FS-2-4000X5	4000	5	120	Grey	Each	4
FS-2-4000X6	4000	6	120	Grey	Each	4

Note: Other lengths and sizes available on request.

FLAT WEBBING SLINGS



DOUBLE PLY FLAT SLINGS

FEATURES AND BENEFITS

- Made from 2 ply polyester webbing
- Light weight & flexible with sewn eyes each end
- Colour coded to International Lifting Standards

STANDARDS

Manufactured & certified to AS1353

CODE	WLL (KG)	LENGTH (M)	WIDTH (MM)	COLOUR	UOM	PACK QTY
FS-2-5000X2	5000	2	150	Red	Each	5
FS-2-5000X2.5	5000	2.5	150	Red	Each	5
FS-2-5000X3	5000	3	150	Red	Each	5
FS-2-5000X4	5000	4	150	Red	Each	4
FS-2-5000X5	5000	5	150	Red	Each	3
FS-2-5000X6	5000	6	150	Red	Each	2

Note: Other lengths and sizes available on request.

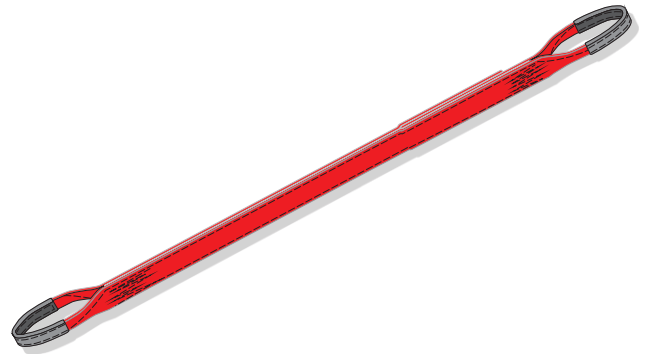

DOUBLE PLY FLAT SLINGS

FEATURES AND BENEFITS

- Made from 2 ply polyester webbing
- Light weight & flexible with sewn eyes each end
- Colour coded to International Lifting Standards

STANDARDS

Manufactured & certified to AS1353

CODE	WLL (KG)	LENGTH (M)	WIDTH (MM)	COLOUR	UOM	PACK QTY
FS-2-6000X2	6000	2	200	Brown	Each	4
FS-2-6000X3	6000	3	200	Brown	Each	3
FS-2-6000X4	6000	4	200	Brown	Each	2
FS-2-6000X5	6000	5	200	Brown	Each	2
FS-2-6000X6	6000	6	200	Brown	Each	2

Note: Other lengths and sizes available on request.

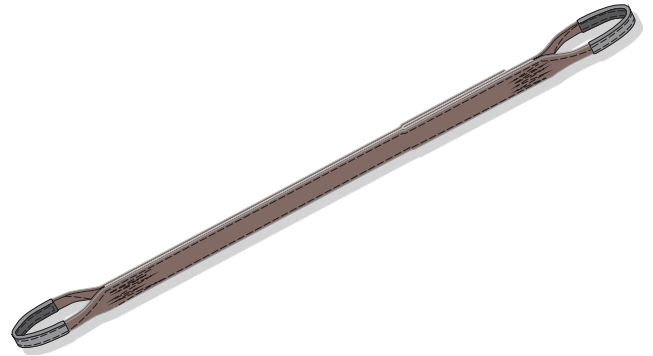



DOUBLE PLY FLAT SLINGS

FEATURES AND BENEFITS

- Made from 2 ply polyester webbing
- Light weight & flexible with sewn eyes each end
- Colour coded to International Lifting Standards

STANDARDS

Manufactured & certified to AS1353

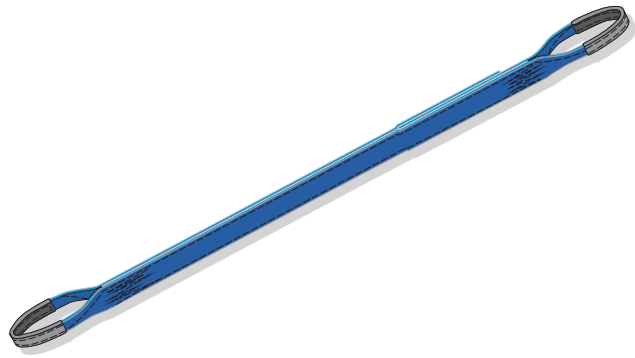

CODE	WLL (KG)	LENGTH (M)	WIDTH (MM)	COLOUR	UOM	PACK QTY
FS-2-8000X3	8000	3	240	Blue	Each	3
FS-2-8000X4	8000	4	240	Blue	Each	2
FS-2-8000X5	8000	5	240	Blue	Each	2
FS-2-8000X6	8000	6	240	Blue	Each	2

Note: Other lengths and sizes available on request.



DOUBLE PLY FLAT SLINGS

FEATURES AND BENEFITS

- Made from 2 ply polyester webbing
- Light weight & flexible with sewn eyes each end
- Colour coded to International Lifting Standards

STANDARDS

Manufactured & certified to AS1353



CODE	WLL (KG)	LENGTH (M)	WIDTH (MM)	COLOUR	UOM	PACK QTY
FS-2-10000X4	10000	4	300	Orange	Each	1
FS-2-10000X6	10000	6	300	Orange	Each	1

Note: Other lengths and sizes available on request.

ROUND SLINGS



Round slings are an all-purpose lifting sling enabling a strong and non-damaging lift of a load. They are extremely light weight and flexible in multiple directions, allowing easy and quick manipulation even when fragile loads are being lifted. Round slings are a continuous loop made from polyester yarn encased in a sleeve of polyester or nylon fabric. The sleeve is constructed, so that it protects the internal rows of yarn filament and keeps them in a parallel formation at all times.

MEGA ROUND SLINGS

FEATURES AND BENEFITS

- All purpose lifting sling made from high strength polyester yarn
- Light weight & flexible continuous looped sling
- Colour coded to International Lifting Standards

STANDARDS

Manufactured & certified to AS4497

CODE	WLL (KG)	LENGTH (M)	WIDTH (MM)	COLOUR	UOM	PACK QTY
MRS1000X0.5	1000	0.5	47	Violet	Each	100
MRS1000X1	1000	1	47	Violet	Each	80
MRS1000X1.5	1000	1.5	47	Violet	Each	50
MRS1000X2	1000	2	47	Violet	Each	40
MRS1000X2.5	1000	2.5	47	Violet	Each	30
MRS1000X3	1000	3	47	Violet	Each	28
MRS1000X4	1000	4	47	Violet	Each	20
MRS1000X5	1000	5	47	Violet	Each	15
MRS1000X6	1000	6	47	Violet	Each	12
MRS1000X8	1000	8	47	Violet	Each	10

Note: Other lengths and sizes available on request.

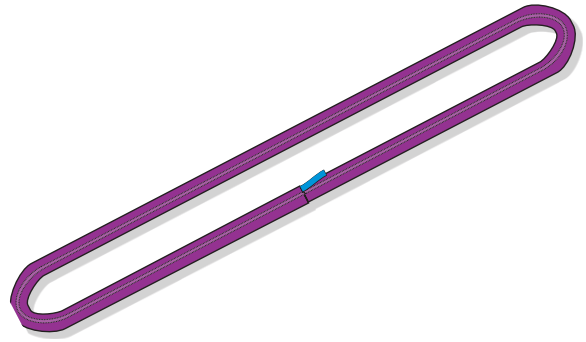

MEGA ROUND SLINGS

FEATURES AND BENEFITS

- All purpose lifting sling made from high strength polyester yarn
- Light weight & flexible continuous looped sling
- Colour coded to International Lifting Standards

STANDARDS

Manufactured & certified to AS4497

CODE	WLL (KG)	LENGTH (M)	WIDTH (MM)	COLOUR	UOM	PACK QTY
MRS2000X0.5	2000	0.5	51	Green	Each	60
MRS2000X1	2000	1	51	Green	Each	40
MRS2000X1.5	2000	1.5	51	Green	Each	30
MRS2000X2	2000	2	51	Green	Each	25
MRS2000X2.5	2000	2.5	51	Green	Each	20
MRS2000X3	2000	3	51	Green	Each	17
MRS2000X3.5	2000	3.5	51	Green	Each	14
MRS2000X4	2000	4	51	Green	Each	12
MRS2000X4.5	2000	4.5	51	Green	Each	12
MRS2000X5	2000	5	51	Green	Each	10
MRS2000X6	2000	6	51	Green	Each	8
MRS2000X8	2000	8	51	Green	Each	6
MRS2000X10	2000	10	51	Green	Each	5

Note: Other lengths and sizes available on request.

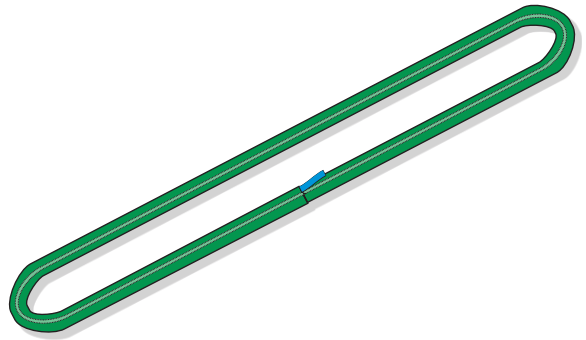



MEGA ROUND SLINGS

FEATURES AND BENEFITS

- All purpose lifting sling made from high strength polyester yarn
- Light weight & flexible continuous looped sling
- Colour coded to International Lifting Standards

STANDARDS

Manufactured & certified to AS4497

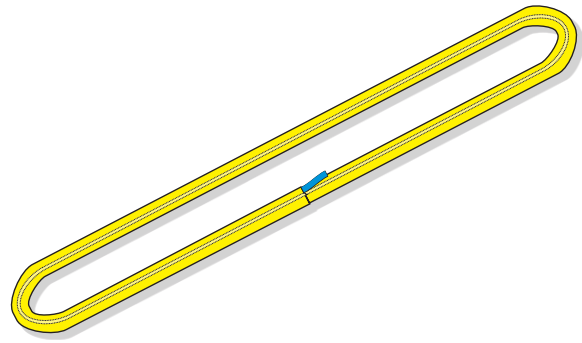

CODE	WLL (KG)	LENGTH (M)	WIDTH (MM)	COLOUR	UOM	PACK QTY
MRS3000X1	3000	1	66	Yellow	Each	35
MRS3000X1.5	3000	1.5	66	Yellow	Each	24
MRS3000X2	3000	2	66	Yellow	Each	18
MRS3000X2.5	3000	2.5	66	Yellow	Each	15
MRS3000X3	3000	3	66	Yellow	Each	13
MRS3000X3.5	3000	3.5	66	Yellow	Each	10
MRS3000X4	3000	4	66	Yellow	Each	10
MRS3000X5	3000	5	66	Yellow	Each	7
MRS3000X6	3000	6	66	Yellow	Each	5
MRS3000X8	3000	8	66	Yellow	Each	5
MRS3000X10	3000	10	66	Yellow	Each	3

Note: Other lengths and sizes available on request.



MEGA ROUND SLINGS

FEATURES AND BENEFITS

- All purpose lifting sling made from high strength polyester yarn
- Light weight & flexible continuous looped sling
- Colour coded to International Lifting Standards

STANDARDS

Manufactured & certified to AS4497

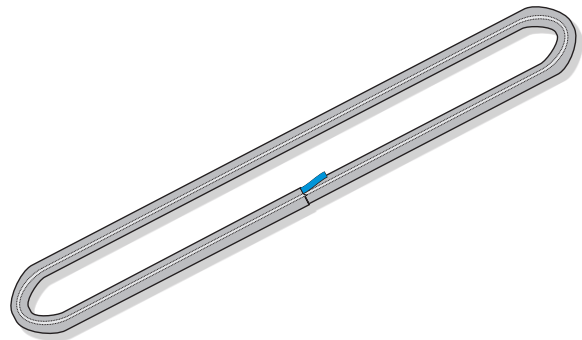

CODE	WLL (KG)	LENGTH (M)	WIDTH (MM)	COLOUR	UOM	PACK QTY
MRS4000X1	4000	1	70	Grey	Each	20
MRS4000X2	4000	2	70	Grey	Each	13
MRS4000X2.5	4000	2.5	70	Grey	Each	10
MRS4000X3	4000	3	70	Grey	Each	9
MRS4000X4	4000	4	70	Grey	Each	6
MRS4000X5	4000	5	70	Grey	Each	5
MRS4000X6	4000	6	70	Grey	Each	4
MRS4000X8	4000	8	70	Grey	Each	3
MRS4000X10	4000	10	70	Grey	Each	2

Note: Other lengths and sizes available on request.

ROUND SLINGS



MEGA ROUND SLINGS

FEATURES AND BENEFITS

- All purpose lifting sling made from high strength polyester yarn
- Light weight & flexible continuous looped sling
- Colour coded to International Lifting Standards

STANDARDS

Manufactured & certified to AS4497

CODE	WLL (KG)	LENGTH (M)	WIDTH (MM)	COLOUR	UOM	PACK QTY
MRS5000X1	5000	1	80	Red	Each	20
MRS5000X2	5000	2	80	Red	Each	10
MRS5000X3	5000	3	80	Red	Each	7
MRS5000X4	5000	4	80	Red	Each	5
MRS5000X5	5000	5	80	Red	Each	4
MRS5000X6	5000	6	80	Red	Each	4
MRS5000X8	5000	8	80	Red	Each	3
MRS5000X10	5000	10	80	Red	Each	2

Note: Other lengths and sizes available on request.

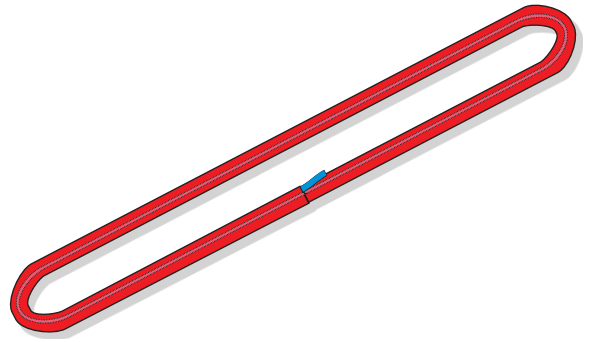

MEGA ROUND SLINGS

FEATURES AND BENEFITS

- All purpose lifting sling made from high strength polyester yarn
- Light weight & flexible continuous looped sling
- Colour coded to International Lifting Standards

STANDARDS

Manufactured & certified to AS4497

CODE	WLL (KG)	LENGTH (M)	WIDTH (MM)	COLOUR	UOM	PACK QTY
MRS6000X1	6000	1	80	Brown	Each	15
MRS6000X2	6000	2	80	Brown	Each	8
MRS6000X3	6000	3	80	Brown	Each	5
MRS6000X4	6000	4	80	Brown	Each	4
MRS6000X5	6000	5	80	Brown	Each	3
MRS6000X6	6000	6	80	Brown	Each	3
MRS6000X8	6000	8	80	Brown	Each	2
MRS6000X10	6000	10	80	Brown	Each	1

Note: Other lengths and sizes available on request.

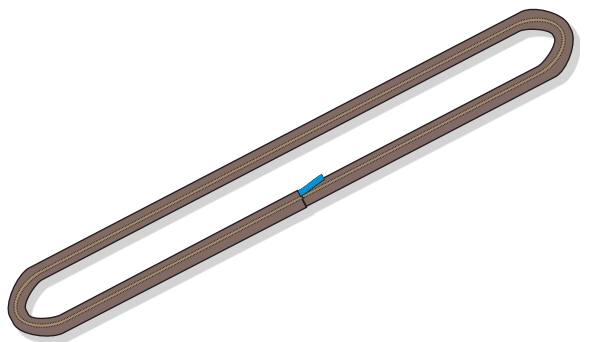



MEGA ROUND SLINGS

FEATURES AND BENEFITS

- All purpose lifting sling made from high strength polyester yarn
- Light weight & flexible continuous looped sling
- Colour coded to International Lifting Standards

STANDARDS

Manufactured & certified to AS4497

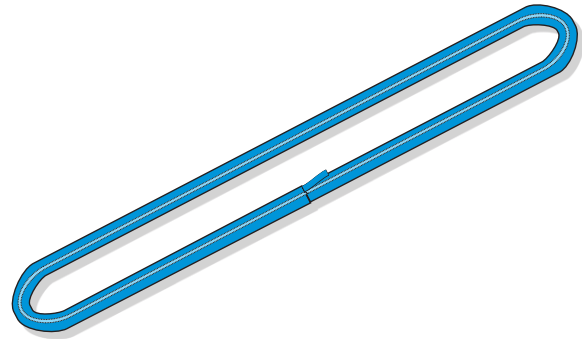

CODE	WLL (KG)	LENGTH (M)	WIDTH (MM)	COLOUR	UOM	PACK QTY
MRS8000X1	8000	1	86	Blue	Each	10
MRS8000X2	8000	2	86	Blue	Each	6
MRS8000X3	8000	3	86	Blue	Each	4
MRS8000X4	8000	4	86	Blue	Each	3
MRS8000X5	8000	5	86	Blue	Each	3
MRS8000X6	8000	6	86	Blue	Each	2

Note: Other lengths and sizes available on request.



MEGA ROUND SLINGS

FEATURES AND BENEFITS

- All purpose lifting sling made from high strength polyester yarn
- Light weight & flexible continuous looped sling
- Colour coded to International Lifting Standards

STANDARDS

Manufactured & certified to AS4497

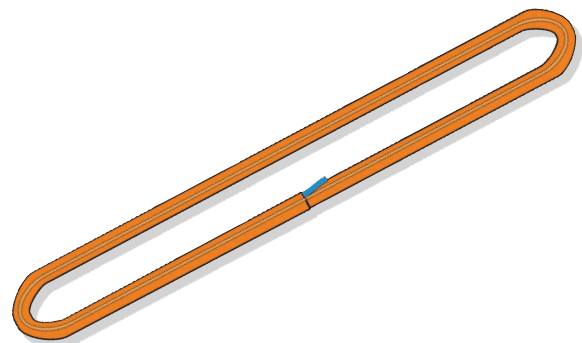

CODE	WLL (KG)	LENGTH (M)	WIDTH (MM)	COLOUR	UOM	PACK QTY
MRS10000X1	10000	1	100	Orange	Each	10
MRS10000X3	10000	3	100	Orange	Each	3
MRS10000X6	10000	6	100	Orange	Each	2

Note: Other lengths and sizes available on request.

JUMBO ROUND SLINGS



JUMBO ROUND SLINGS

FEATURES AND BENEFITS

- Lifting sling suitable for heavy lifting applications
- Made from high strength polyester yarn

STANDARDS

Manufactured & certified to AS4497

CODE	WLL (KG)	LENGTH (M)	WIDTH (MM)	COLOUR	UOM	PACK QTY
SRS20000X3	20000	3	80	Orange	Each	2
SRS20000X4	20000	4	80	Orange	Each	1
SRS20000X5	20000	5	80	Orange	Each	1
SRS20000X6	20000	6	80	Orange	Each	1

Note: Other lengths and sizes available on request.

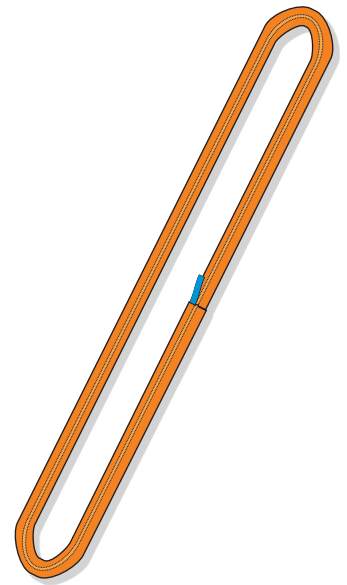

JUMBO ROUND SLINGS

FEATURES AND BENEFITS

- Lifting sling suitable for heavy lifting applications
- Made from high strength polyester yarn

STANDARDS

Manufactured & certified to AS4497

CODE	WLL (KG)	LENGTH (M)	WIDTH (MM)	COLOUR	UOM	PACK QTY
SRS30000X3	30000	3	90	Orange	Each	1
SRS30000X4	30000	4	90	Orange	Each	5
SRS30000X5	30000	5	90	Orange	Each	4
SRS30000X6	30000	6	90	Orange	Each	3

Note: Other lengths and sizes available on request.

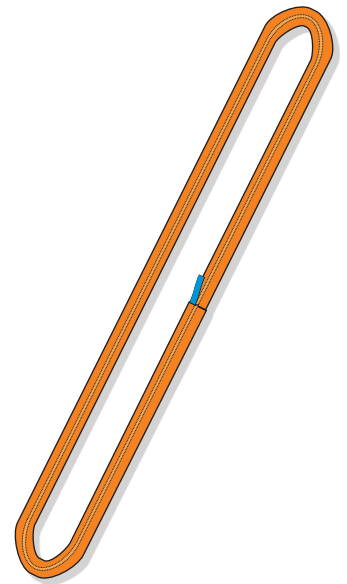

JUMBO ROUND SLINGS

FEATURES AND BENEFITS

- Lifting sling suitable for heavy lifting applications
- Made from high strength polyester yarn

STANDARDS

Manufactured & certified to AS4497

CODE	WLL (KG)	LENGTH (M)	WIDTH (MM)	COLOUR	UOM	PACK QTY
SRS50000X3	50000	3	120	Orange	Each	1
SRS50000X4	50000	4	120	Orange	Each	3
SRS50000X6	50000	6	120	Orange	Each	2

Note: Other lengths and sizes available on request.

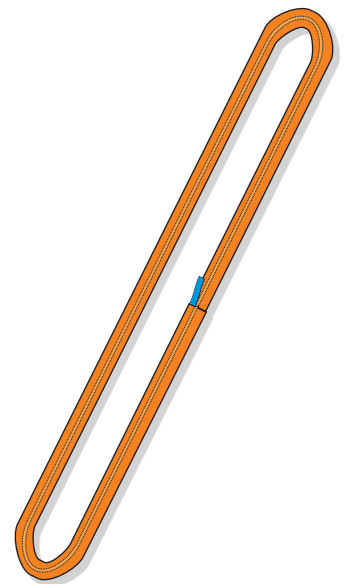

TWIN-PATH® TOW SLINGS FROM 5 TO 600 TONNES

Twin-Path® slings are manufactured in Australia by Beaver Brands, (under licence from Slingmas), and are constructed with K-Spec® high performance fibres which will not stretch under load - enabling accurate control. The slings consist of a Covermax® outer cover, which is four times more abrasion resistant than other slings with standard polyester covers.

WEIGHT ADVANTAGE

- 80% lighter than steel wire rope/chain slings
- 50% lighter than polyester.

CONTROL OF SLINGS

- Lightweight allowing better control by operators.

STORAGE, RETRIEVAL AND SALVAGE

- Easy rolled and folded for storage
- Ease of transport.

WEAR RESISTANT COVERMAX® OUTER COVER WOVEN

- Outer cover fabric is more abrasive resistant than common nylon or polyester.

REDUCED RIGGING TIMES

- Up to 80% reduction in rigging times.

SAFETY

- Reduce exposure to back and work related injury.

PROTECTIVE SLEEVES

- Covermax® pads and sleeves available if required.

TELL TAILS / OPTICAL FIBRES

- Allows continual monitoring of sling safety.

APPLICATIONS

- Special and heavy lifts
- Mining, towing, lifting
- Marine - Naturally Buoyant - K-Spec® does not absorb moisture
- Power stations.



AUSTRALIAN MADE

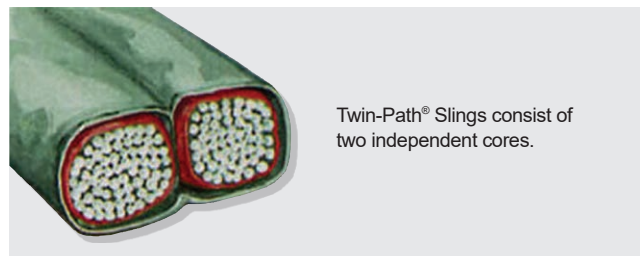

Twin-Path® Slings consist of two independent cores.



If the early warning indicators (EWI) is missing, the sling may be unfit for use.

SUPERIOR PATENTED DESIGN FEATURES

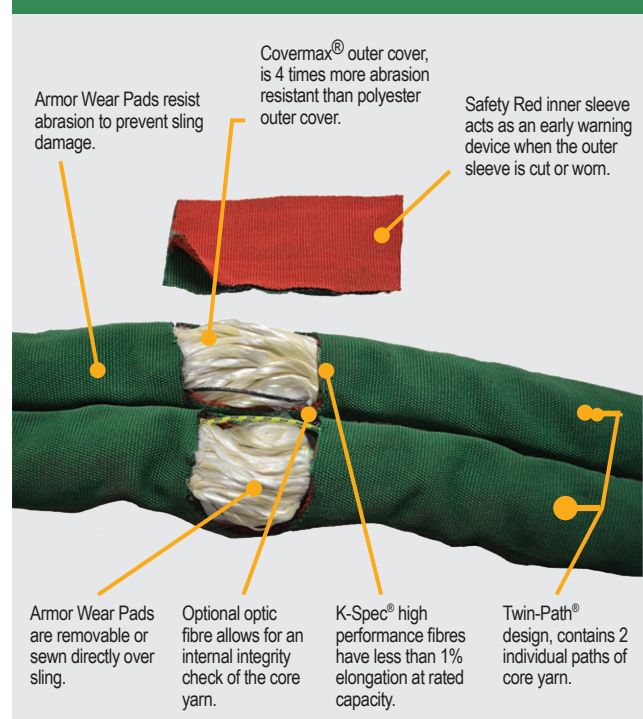

TWIN-PATH® LIFTING SLINGS



TWIN-PATH® TECHNICAL SPECIFICATIONS

FEATURES AND BENEFITS

- High performance lifting sling
- Constructed with unique K-Spec® fibres
- Water resistant Covermax® cover
- 80% lighter than steel wire rope/chains
- Tell tails/optical fibres to monitor the safety of the sling
- 50% lighter than polyester

TWIN-PATH® CHART 7:1 - LIFTING - UP TO 600 TONNES

CODE	VERTICAL WLL (kg)	CHOKE WLL (kg)	BASKET WLL (kg)	60 DEG WLL	TUBE WIDTH (mm)	WEIGHT PER METRE (kg)
TPXC5	5000	4000	10000	8500	75	0.57
TPXC6	6000	4800	12000	10200	75	0.68
TPXC8	8000	6400	16000	13600	75	0.91
TPXC10	10000	8000	20000	17000	100	1.14
TPXC12	12000	9600	24000	20400	125	1.36
TPXC15	15000	12000	30000	25500	125	1.7
TPXC20	20000	16000	40000	34000	125	2.27
TPXC25	25000	20000	50000	42500	150	2.84
TPXC30	30000	24000	60000	51000	150	3.41
TPXC35	35000	28000	70000	59500	200	3.98
TPXC40	40000	32000	80000	68000	200	4.55
TPXC45	45000	36000	90000	76500	200	5.11
TPXC50	50000	40000	100000	85000	200	5.68
TPXC55	55000	44000	110000	93500	250	6.25
TPXC60	60000	48000	120000	102000	250	6.82
TPXC65	65000	52000	130000	110500	250	7.39
TPXC70	70000	56000	140000	119000	300	7.96
TPXC75	75000	60000	150000	127500	300	8.52
TPXC80	80000	64000	160000	136000	300	9.09
TPXC85	85000	68000	170000	144500	300	9.66
TPXC90	90000	72000	180000	153000	300	10.23
TPXC95	95000	76000	190000	161500	300	10.8
TPXC100	100000	80000	200000	170000	300	11.37
TPXC105	105000	84000	210000	178500	250 & 100	11.93
TPXC110	110000	88000	220000	187000	250 & 100	12.5
TPXC115	115000	92000	230000	195500	250 & 100	13.07
TPXC120	120000	96000	240000	204000	250 & 100	13.64
TPXC125	125000	100000	250000	212500	250 & 100	14.21
TPXC130	130000	104000	260000	221000	250 & 100	14.77
TPXC135	135000	108000	270000	229500	250 & 150	15.34
TPXC140	140000	112000	280000	238000	250 & 150	15.91
TPXC145	145000	116000	290000	246500	250 & 150	24.72
TPXC150	150000	120000	300000	255000	250 & 150	25.27
TPXC155	155000	124000	310000	263500	250 & 150	26.42
TPXC160	160000	128000	320000	272000	250 & 150	27.28
TPXC165	165000	132000	330000	280500	250 & 150	28.13
TPXC170	170000	136000	340000	289000	250 & 150	28.98
TPXC175	175000	140000	350000	297500	250 & 150	29.83
TPXC180	180000	144000	360000	306000	250 & 200	30.69
TPXC185	185000	148000	370000	314500	250 & 200	31.54
TPXC190	190000	152000	380000	323000	250 & 200	32.39
TPXC195	195000	156000	390000	331500	250 & 200	33.24
TPXC200	200000	160000	400000	340000	250 & 200	34.1

Note: Up to 600 tonne - Please contact your local branch for details. * Dimensions can vary according to the hardware or bearing points the slings are used with. Minimum is "tapered" width; Maximum is the flat tubing width. Test certificates supplied with all slings. To obtain the MBS (Minimum Breaking Strength) for towing multiply the WLL by 5. Example: TPXC5 = WLL 5000kg x 5 = 25,000kg.



TWIN-PATH® TECHNICAL SPECIFICATIONS

FEATURES AND BENEFITS

- High performance lifting sling
- Constructed with unique K-Spec® fibres
- Water resistant Covermax® cover
- 80% lighter than steel wire rope/chains
- Tell tails/optical fibres to monitor the safety of the sling
- 50% lighter than polyester



TWIN-PATH® CHART 5:1 - TOWING

CODE	MBS (kg)	TUBE WIDTH (mm)	WEIGHT PER METRE (kg)
TPXC5	25000	75	0.3608
TPXC6	30000	75	0.4330
TPXC8	40000	75	0.5773
TPXC10	50000	75	0.7216
TPXC12	60000	100	0.8659
TPXC15	75000	100	1.0824
TPXC20	100000	125	1.4432
TPXC25	125000	125	1.8040
TPXC30	150000	150	2.1648
TPXC35	175000	150	2.5256
TPXC40	200000	150	2.8864
TPXC45	225000	150	3.2472
TPXC50	250000	200	3.6080
TPXC55	275000	200	3.9688
TPXC60	300000	200	4.3296
TPXC65	325000	200	4.6904
TPXC70	350000	200	5.0512
TPXC75	375000	250	5.4120
TPXC80	400000	250	5.7728
TPXC85	425000	250	6.1336
TPXC90	450000	250	6.4944
TPXC95	475000	300	6.8552
TPXC100	500000	300	7.2160

CODE	MBS (kg)	TUBE WIDTH (mm)	WEIGHT PER METRE (kg)
TPXC105	525000	300	7.5768
TPXC110	550000	300	7.9376
TPXC115	575000	300	8.2984
TPXC120	600000	300	8.6592
TPXC125	625000	300	9.0200
TPXC130	650000	300	9.3808
TPXC135	675000	300	9.7416
TPXC140	700000	300	10.1024
TPXC145	725000	250 & 100	15.6948
TPXC150	750000	250 & 100	16.2360
TPXC155	775000	250 & 100	16.7772
TPXC160	800000	250 & 100	17.3184
TPXC165	825000	250 & 100	17.8596
TPXC170	850000	200 & 150	18.4008
TPXC175	875000	200 & 150	18.9420
TPXC180	900000	200 & 150	19.4832
TPXC185	925000	250 & 150	20.0244
TPXC190	950000	250 & 150	20.5656
TPXC195	975000	250 & 150	21.1068
TPXC200	1000000	250 & 150	21.6480
TPXC250	1250000	250 & 150	27.0600
TPXC300	1500000	200 & 200	43.2960

Note: Other lengths and sizes available on request.





EQUALISER BLOCK

The Equalizer Block is used to maintain tension on all legs of the sling during a lift. Rather than adjusting slings and hooks prior to completing a lift, the Equalizer Block will automatically adjust itself when pressure is put on the device from the sling. This was designed specifically for Twin-Path® slings.

CODE	CAPACITY (5:1 DF)	INSIDE WIDTH (mm)	SUGGESTED SLING FOR 90° BASKET	BLOCK WEIGHT (kg)
SEB10	10 US ton	70mm	TPXCF1000	20kg
SEB25	25 US ton	100mm	TPXCF2500	36kg
SEB50	50 US ton	150mm	TPXCF5000	100kg
SEB75	75 US ton	150mm	TPXCF7500	122kg
SEB125M	125 metric ton	200mm	TPXCF15000	290kg

Note: Other lengths and sizes available on request.



The equaliser block automatically adjusts itself when under pressure.

TWIN-PATH® ADJUSTABLE BRIDLES

Twin-Path® Adjustable Bridles are a very useful rigging tool. They replace standard two or four leg bridles, with the additional value of self-adjustment to awkward loads. One leg has twice the capacity of the other leg. As tension is applied, Twin-Path® Adjustable Bridles self-adjust over the centre of gravity to find the lifting point for level, load handling.

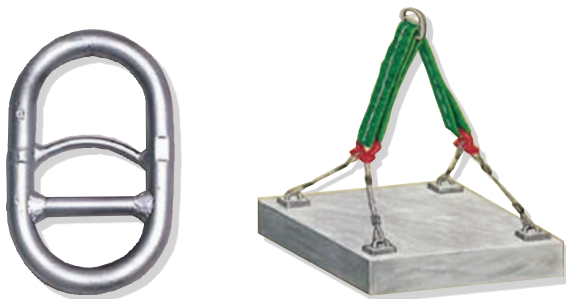

Twin-Path® adjustable bridles self adjust over the centre of gravity.

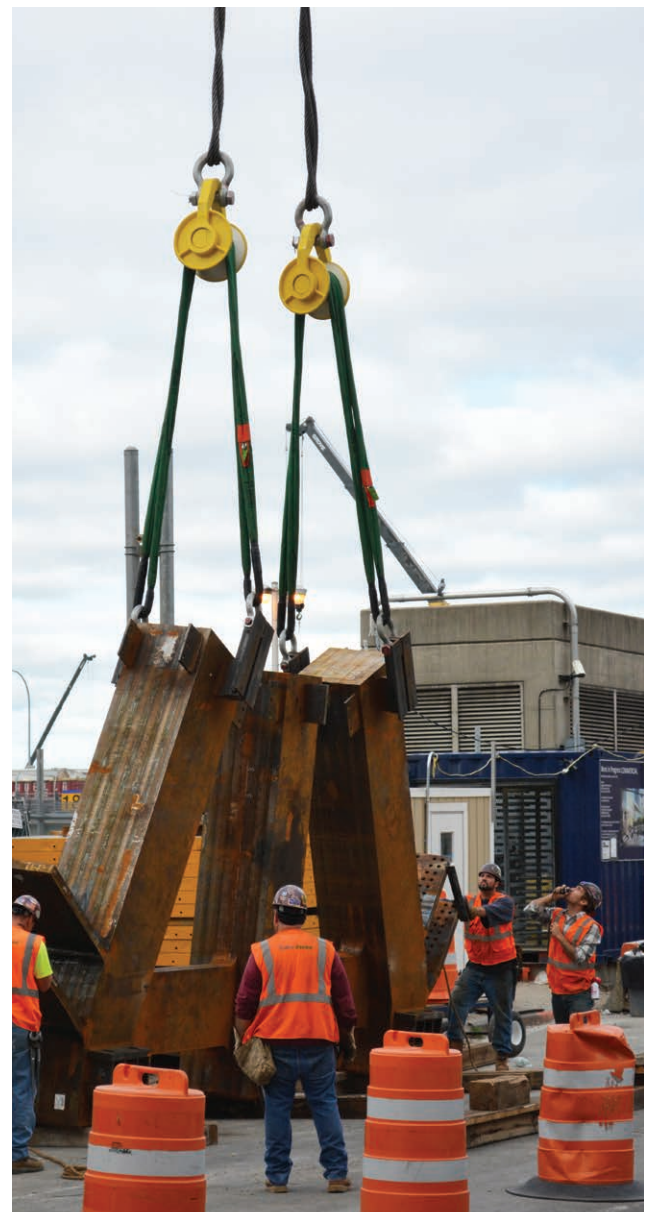



BOAT LIFTING SLINGS

FEATURES AND BENEFITS

- Manufactured in two parts with 3 or 4 finger joints
- Chine pads available for protection from extrusions & keels
- Custom lengths available upon request
- Supplied with test certificate

STANDARDS

Manufactured & certified to AS4498

CODE	NUMBER OF FINGERS	SLING LENGTH (m)	WLL VERTICAL SLING (kg)	BASKET SLING (kg)
545320F	3	2	10,000	20,000
545330F	3	3	10,000	20,000
545340F	3	4	10,000	20,000
545350F	3	5	10,000	20,000
545360F	3	6	10,000	20,000
545370F	3	7	10,000	20,000
545380F	3	8	10,000	20,000
545420F	4	2	10,000	20,000
545430F	4	3	10,000	20,000
545440F	4	4	10,000	20,000
545450F	4	5	10,000	20,000
545460F	4	6	10,000	20,000
545470F	4	7	10,000	20,000
545480F	4	8	10,000	20,000

Note: Other lengths and sizes available on request.

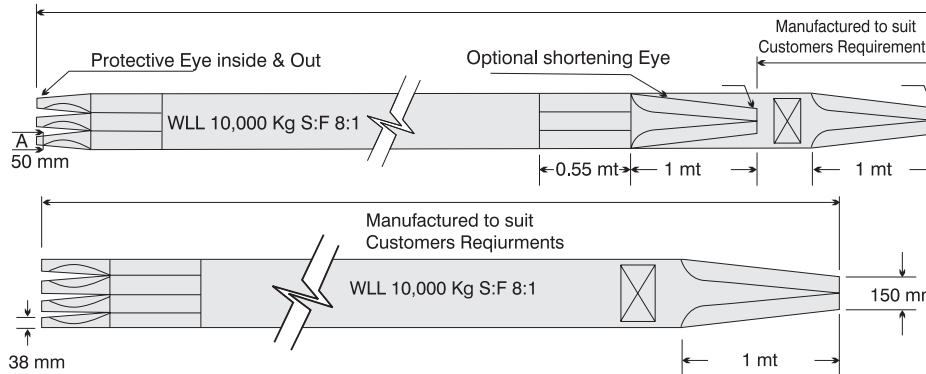
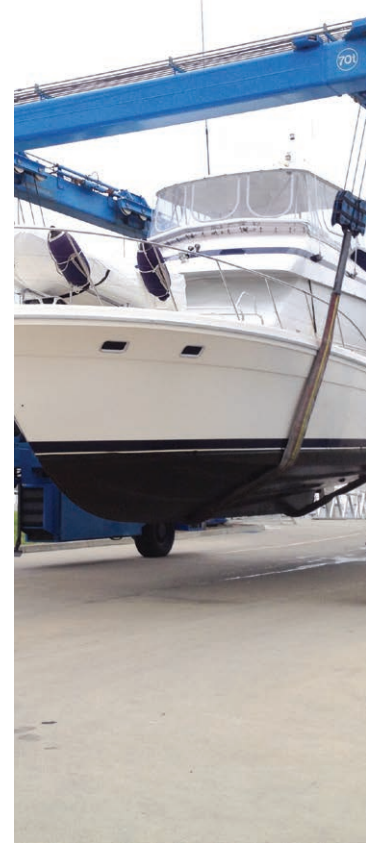

OPTIONAL SHORTENING EYE

CODE	EYE LENGTH	LENGTH (m)
545308F	1	1.5

CHINE & KEEL PADS

Standard Chine Pad

Standard Keel Pad with Lead Insert

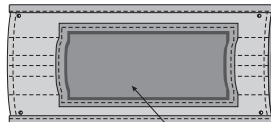
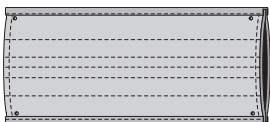

Sheet Lead Inserts (one side only) 10 Kg Total

Note: Please specify length of pads required when ordering.



FOR SAFE WORKING LIVES



safety

Bunzl Safety

55 Sarah Andrews Close
Erskine Park NSW 2759

1800 967 573

bunzlsafety.com.au